

Profiled Sheet FTB 7 façade

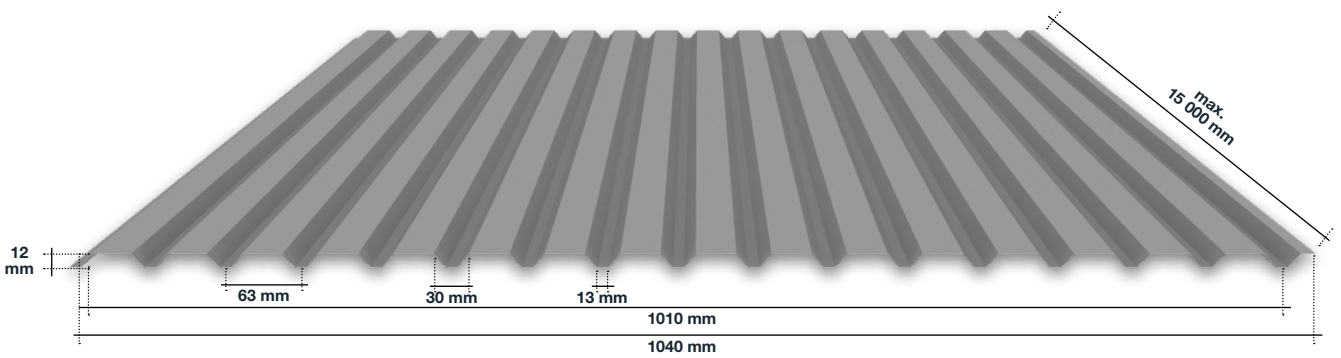

Characteristics:

		STANDARD	BY REQUEST	
	Steel grade	S220GD+Z	DX51D+Z, S250GD+Z a S350GD+Z	
	Steel thickness	0,4 a 0,5 mm	0,6 mm	0,7 mm
Metallic support	Galvanized	140 a 180 gr/m ²		
	Pre-painted	Polyester (25 µm)	PVDF (25/35 µm)	HDX (55 µm)
	Colours	Available in the RAL chart		Remaining

If you need other characteristics that aren't described on the table(s), please contact FTB technical department.