

# Profiled Sheet FTB 5 façade

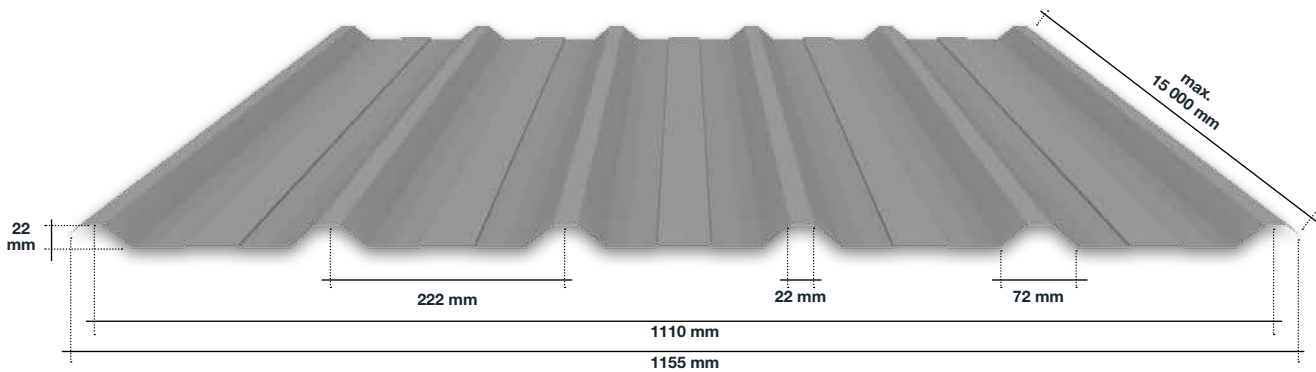

## Characteristics:

		STANDARD	BY REQUEST	
	<b>Steel grade</b>	S220GD+Z	DX51D+Z, S250GD+Z a S350GD+Z	
	<b>Steel thickness</b>	0,4 a 0,5 mm	0,6 mm	0,7 mm
<b>Metallic support</b>	<b>Galvanized</b>	140 a 180 gr/m <sup>2</sup>	Up to 275 gr/m <sup>2</sup>	
	<b>Pre-painted</b>	Polyester (25 µm)	PVDF (25/35 µm)	HDX (55 µm)
	<b>Colours</b>	Available in the RAL chart		Remaining

If you need other characteristics that aren't described on the table(s), please contact FTB technical department.